



# Installation instructions, accessories

Volvo Car Corporation Gothenburg, Sweden

Instruction No	Version	Part. No.
31390248	1.0	31390242, 31390245

## Steering wheel



# Installation instructions, accessories

Volvo Car Corporation Gothenburg, Sweden

## Equipment

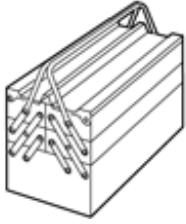

IMG-345497



IMG-239664

**Nm**  
**lbf.ft**



IMG-239667

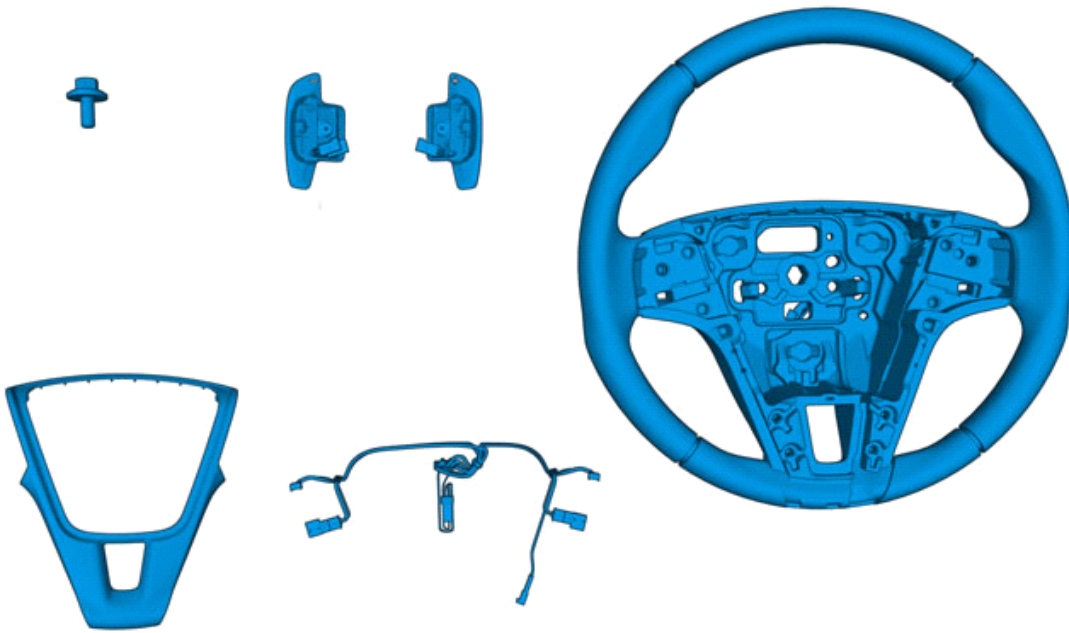

IMG-378948



# Installation instructions, accessories

Volvo Car Corporation Gothenburg, Sweden

## Information

1

Read through all of the instructions before starting installation.

Notifications and warning texts are for your safety and to minimise the risk of something breaking during installation.

Ensure that all tools stated in the instructions are available before starting installation.

Certain steps in the instructions are only presented in the form of images. Explanatory text is also given for more complicated steps.

In the event of any problems with the instructions or the accessory, contact your local Volvo dealer.

## Further information

2

These installation instructions show installation on left hand drive cars.

When installing on right-hand drive cars, perform the procedures on the opposite side and/or mirrored.

Where the procedure differs, the right-hand version is also shown with text and image.

## Color symbols

3

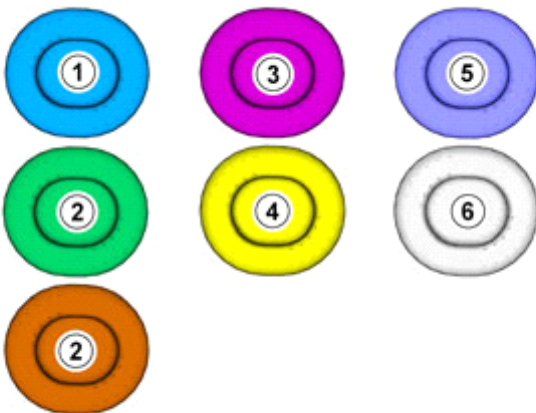

IMG-363036

### Note!

This colour chart displays (in colour print and electronic version) the importance of the different colours used in the images of the method steps.

1. Used for focused component, the component with which you will do something.
2. Used as extra colors when you need to show or differentiate additional parts.
3. Used for attachments that are to be removed/installed. May be screws, clips, connectors, etc.
4. Used when the component is not fully removed from the vehicle but only hung to the side.
5. Used for standard tools and special tools.
6. Used as background color for vehicle components.



# Installation instructions, accessories

Volvo Car Corporation Gothenburg, Sweden

## Removal

4

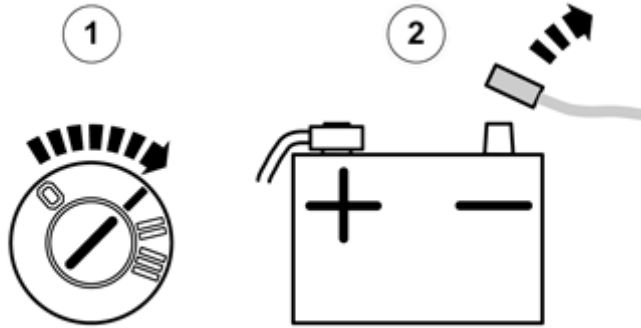

### Warning!

The supplemental restraint system (SRS) is active for a certain length of time after the power supply has been disconnected. Wait for a minimum of 30 seconds before disconnecting or removing any SRS components.

1. Turn on the ignition.
2. Remove the battery's negative cable.

IMG-332180

5

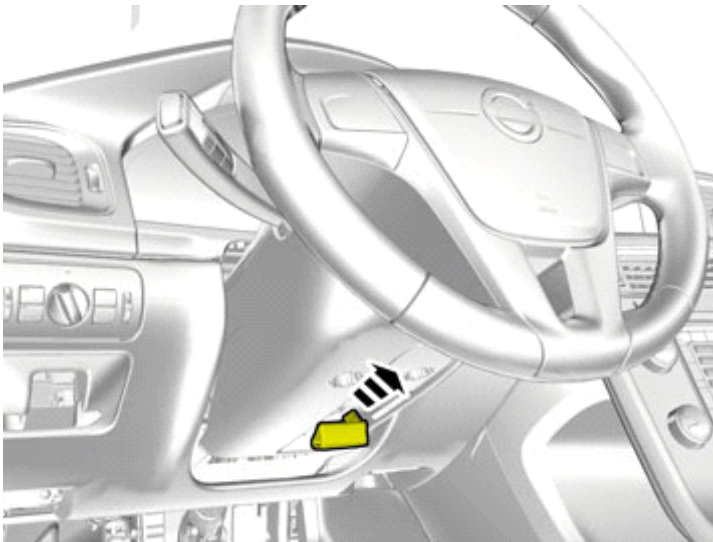

IMG-345551



# Installation instructions, accessories

Volvo Car Corporation Gothenburg, Sweden

6

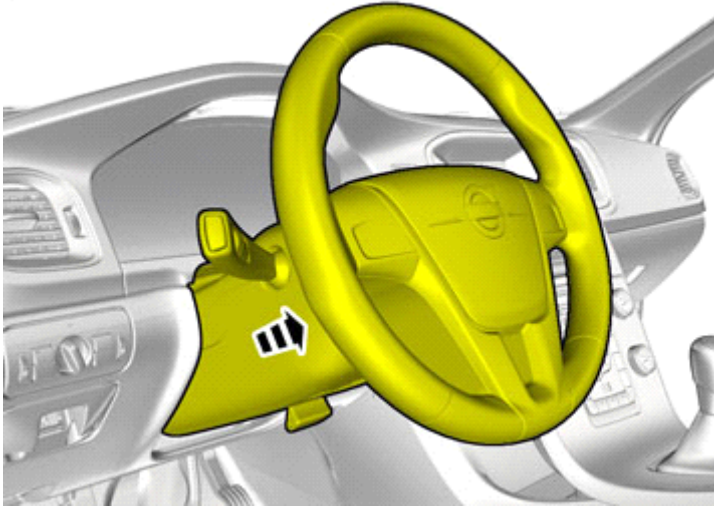

IMG-345553

7

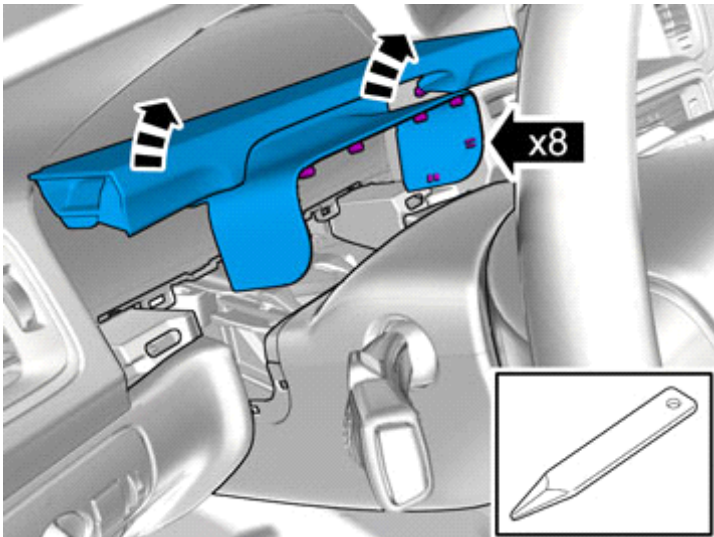

IMG-344722

Remove the panel.

8

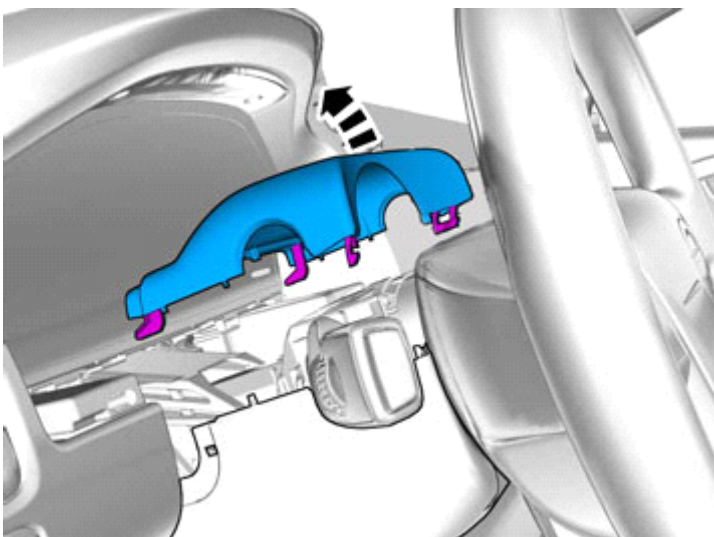

IMG-345554

Remove the panel.



# Installation instructions, accessories

Volvo Car Corporation Gothenburg, Sweden

9

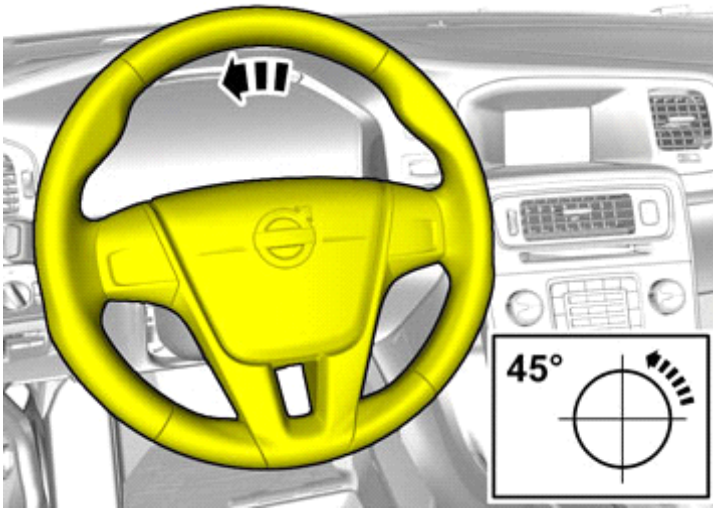

IMG-345555

10

mm

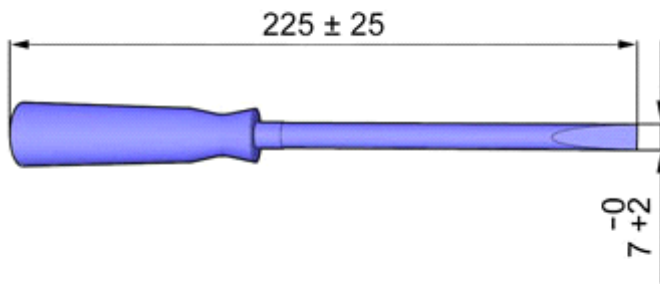

IMG-337683

11

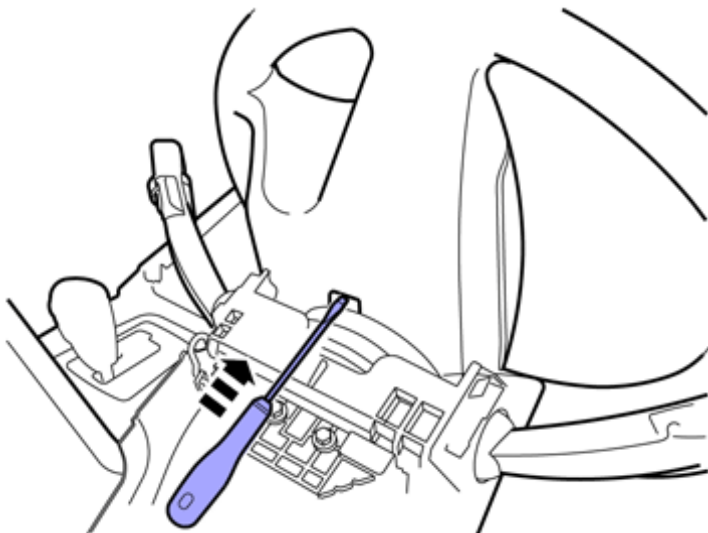

IMG-344725



# Installation instructions, accessories

Volvo Car Corporation Gothenburg, Sweden

12

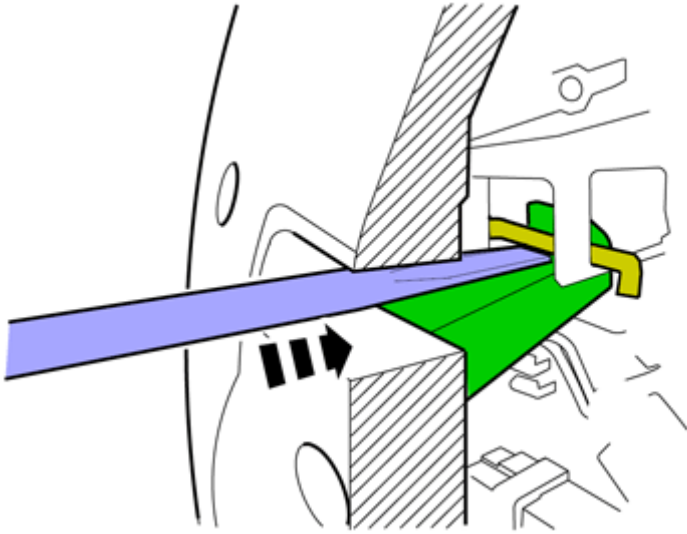

IMG-344726

13

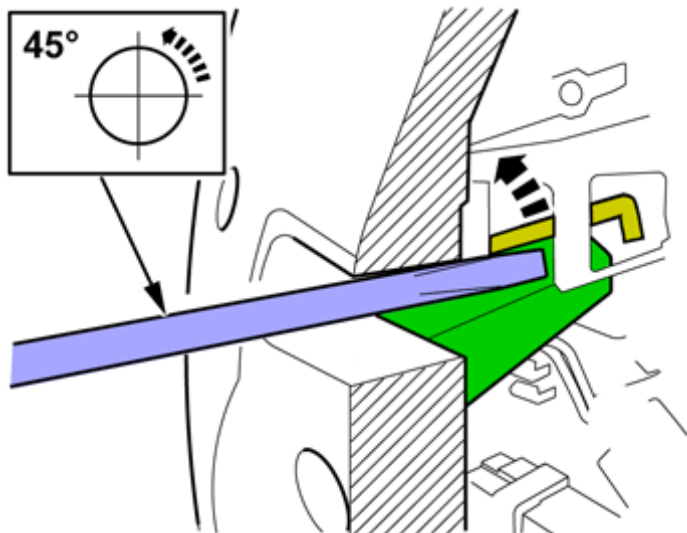

IMG-344727



# Installation instructions, accessories

Volvo Car Corporation Gothenburg, Sweden

14

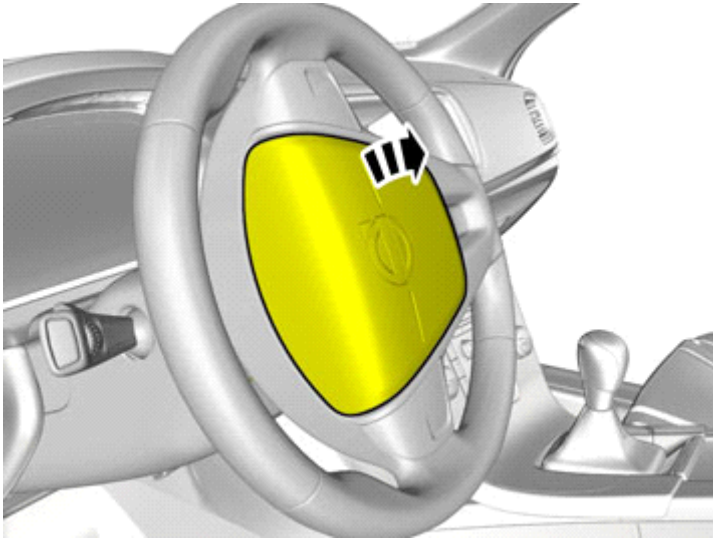

IMG-345556

15

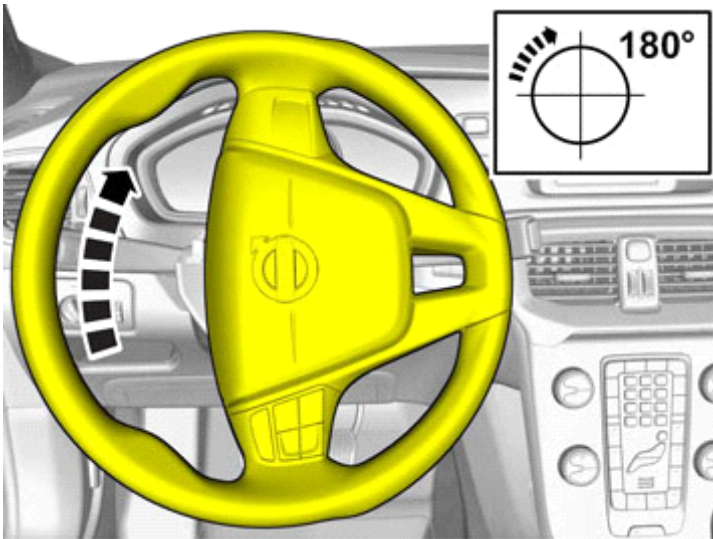

IMG-349359

Repeat on the other side.

16



IMG-345558

Repeat the steps when removing on opposite side.

Turn the steering wheel into neutral position.





# Installation instructions, accessories

Volvo Car Corporation Gothenburg, Sweden

17

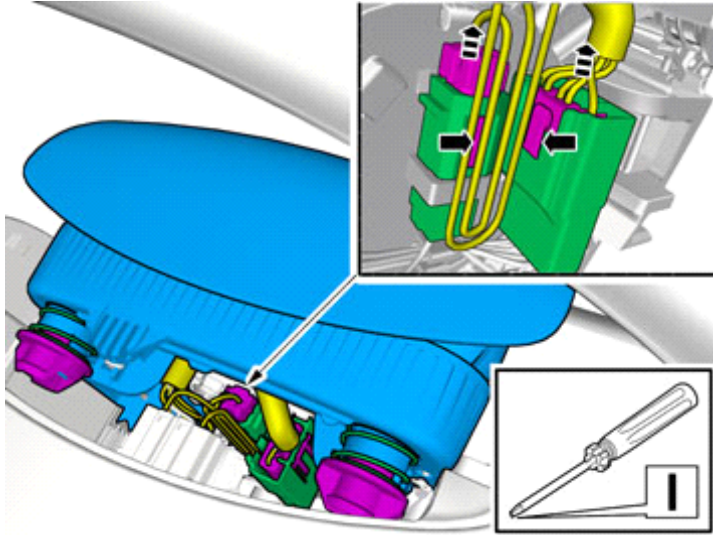

IMG-344730

Release the connector's catch.

Disconnect the connectors.

18

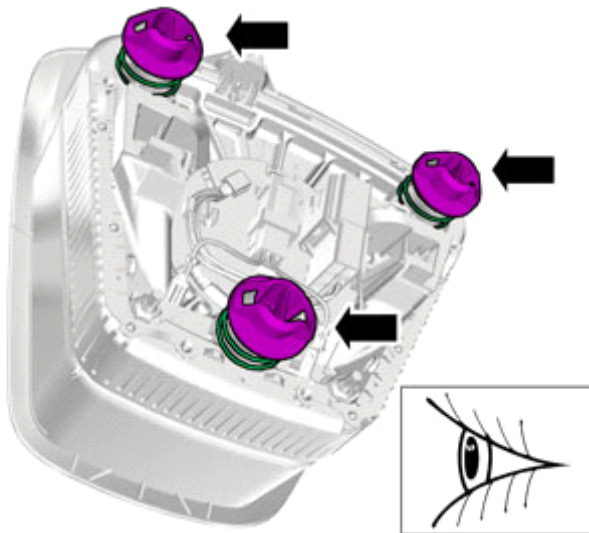

IMG-344731

19

**Warning!**  
Place the airbag module with the front side facing up in a safe storage area during work.



# Installation instructions, accessories

Volvo Car Corporation Gothenburg, Sweden

20

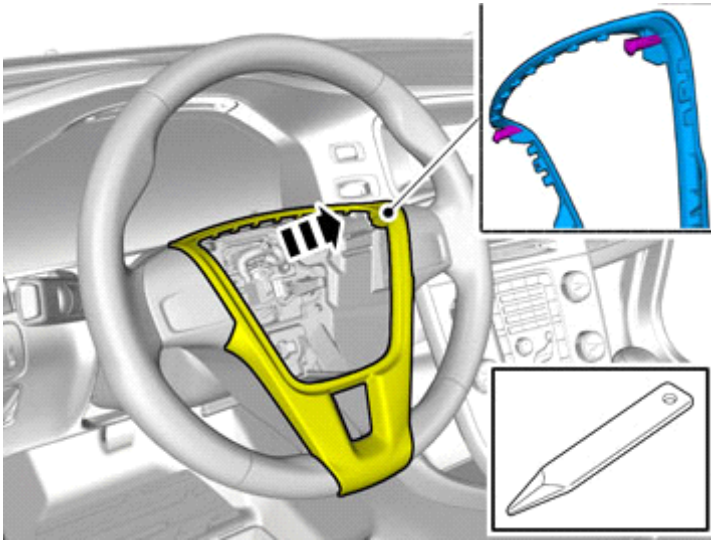

IMG-345559

**Note!**

This step requires considerable force.

Detach the panel.

21

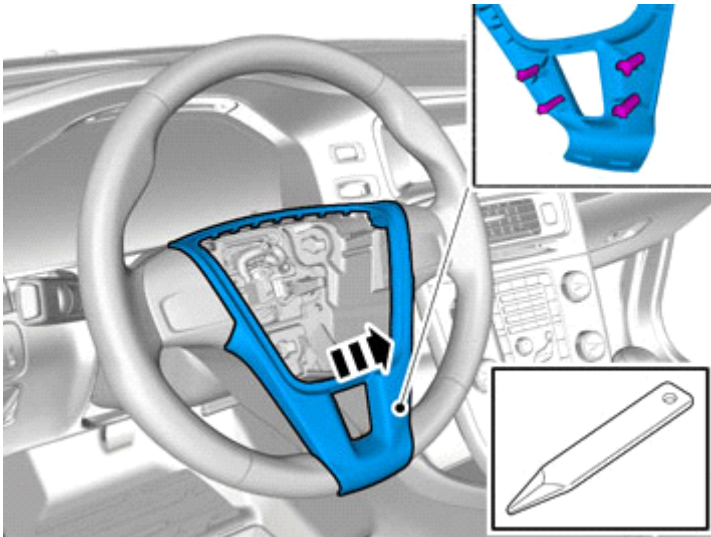

IMG-345560

**Note!**

This step requires considerable force.

Remove the panel.

22

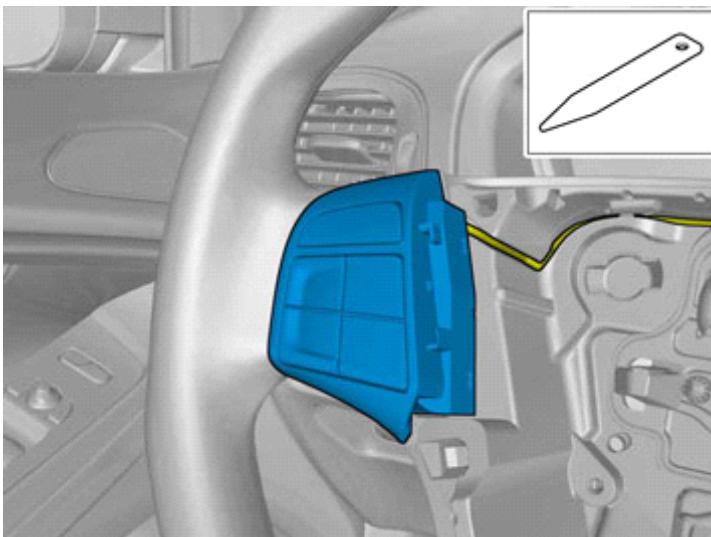

IMG-373323

**Note!**

This step requires considerable force.

Repeat on the other side.



# Installation instructions, accessories

Volvo Car Corporation Gothenburg, Sweden

23

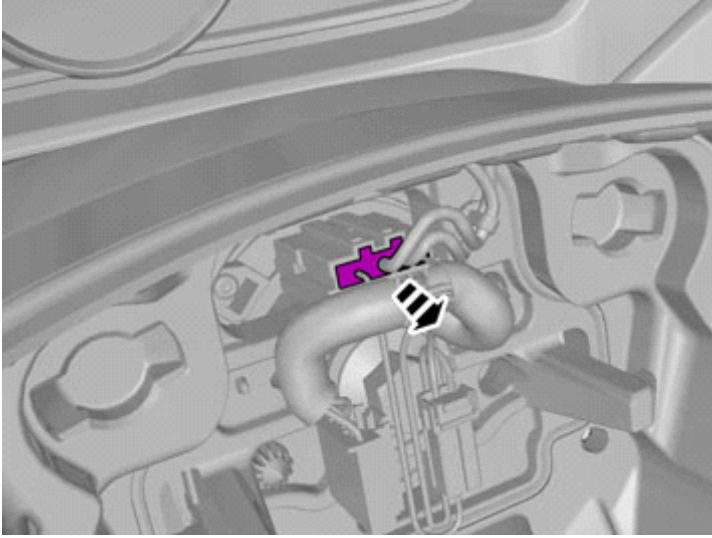

IMG-373322

Disconnect the connector.

24

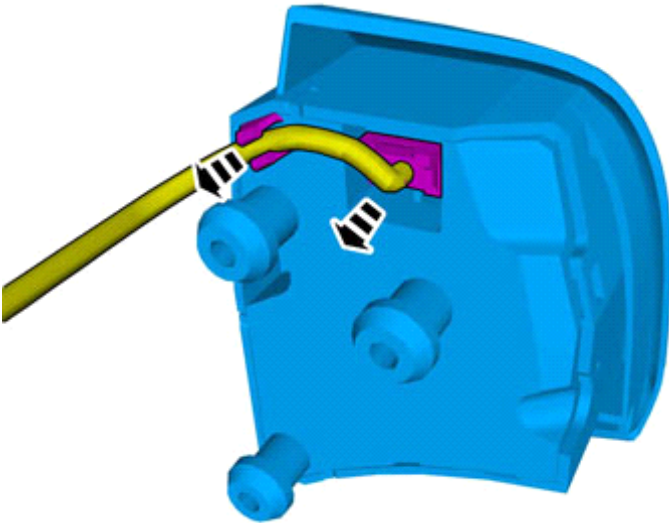

IMG-344121

Disconnect the connector.

Repeat on the other side.

25

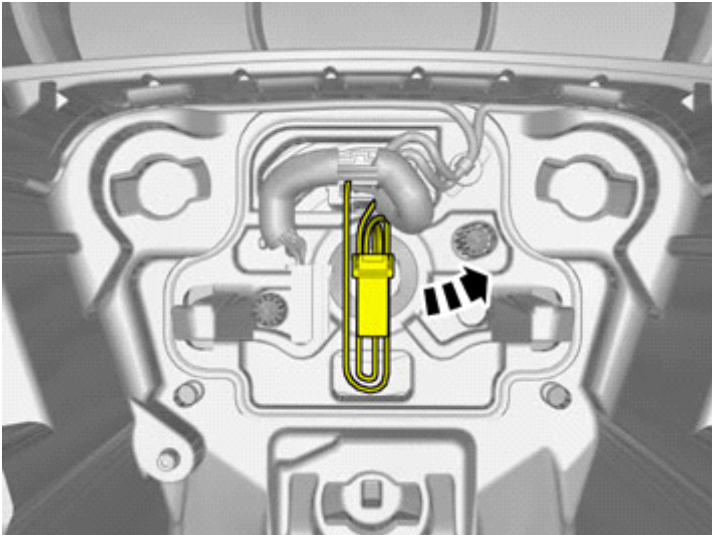

IMG-373344



# Installation instructions, accessories

Volvo Car Corporation Gothenburg, Sweden

26

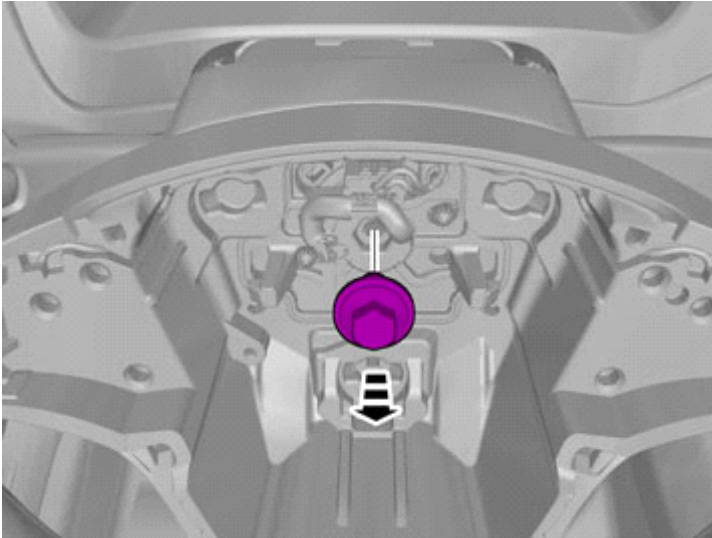

IMG-373345

27

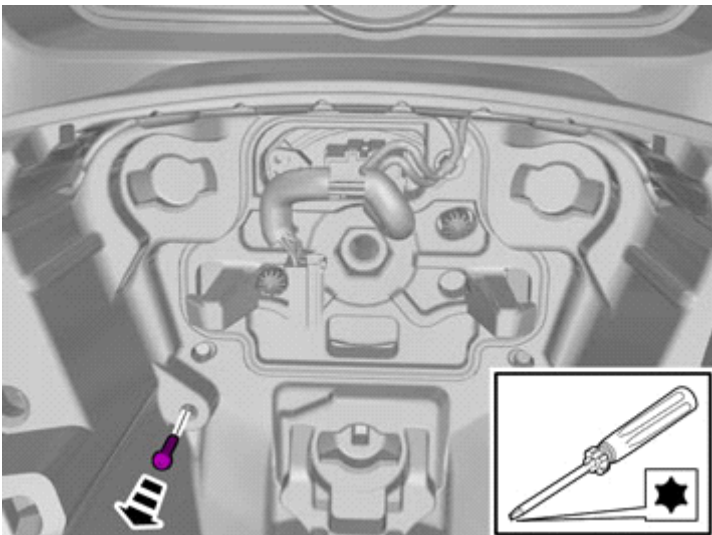

IMG-373339

Remove the screws.



# Installation instructions, accessories

Volvo Car Corporation Gothenburg, Sweden

28

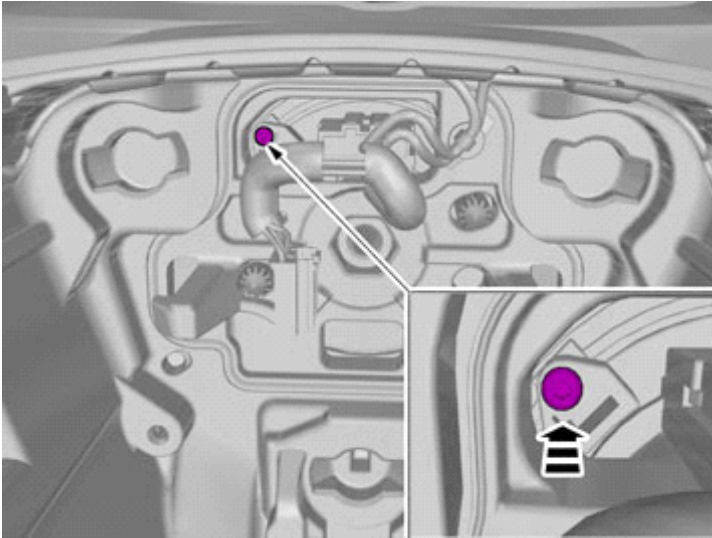

IMG-373341

Reinstall the screw.

Use hands only.

29



IMG-373348

Remove the part carefully

30

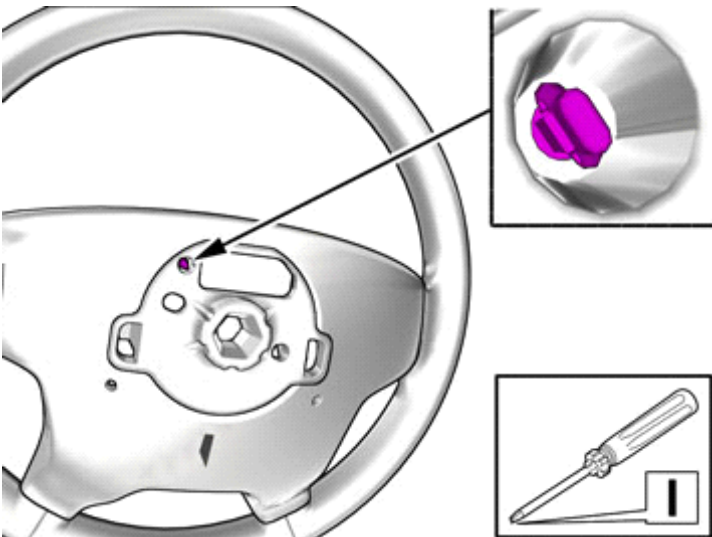

IMG-344511

Remove the cable harness clips.



# Installation instructions, accessories

Volvo Car Corporation Gothenburg, Sweden

31

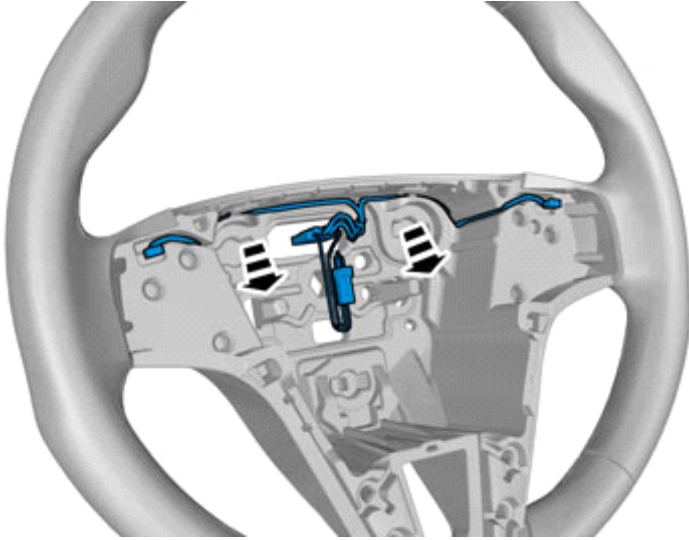

IMG-373349

## Accessory installation

32

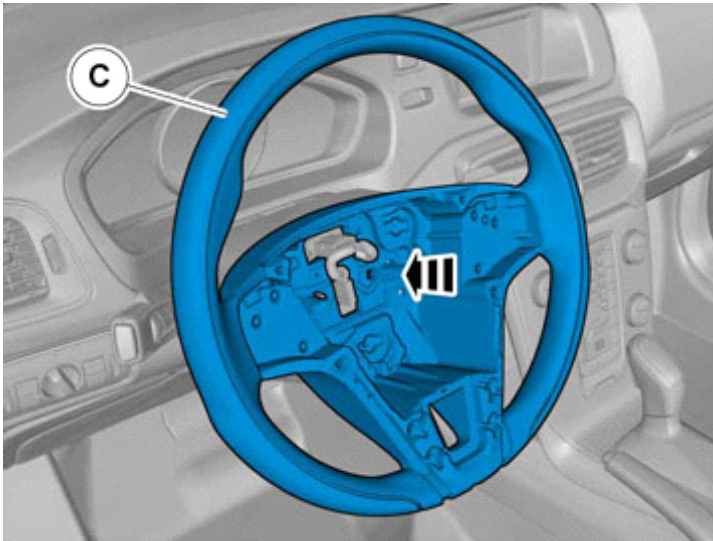

IMG-373366



# Installation instructions, accessories

Volvo Car Corporation Gothenburg, Sweden

33

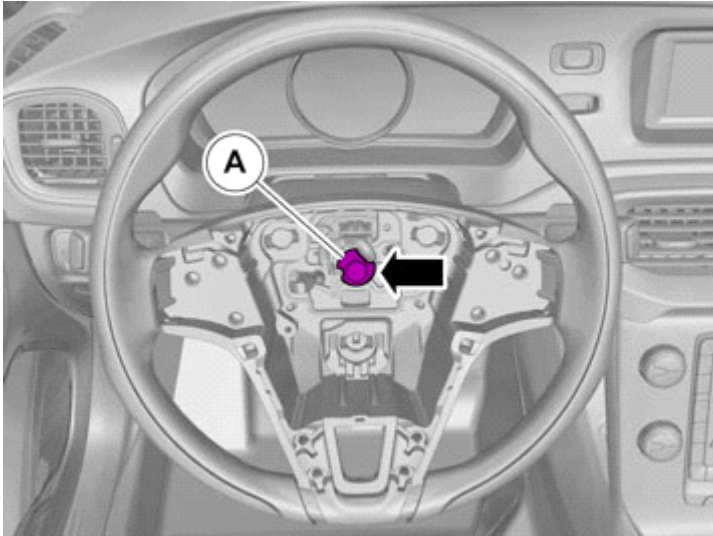

IMG-373383

Install the screw.

34



IMG-373392

Remove the screw.

35

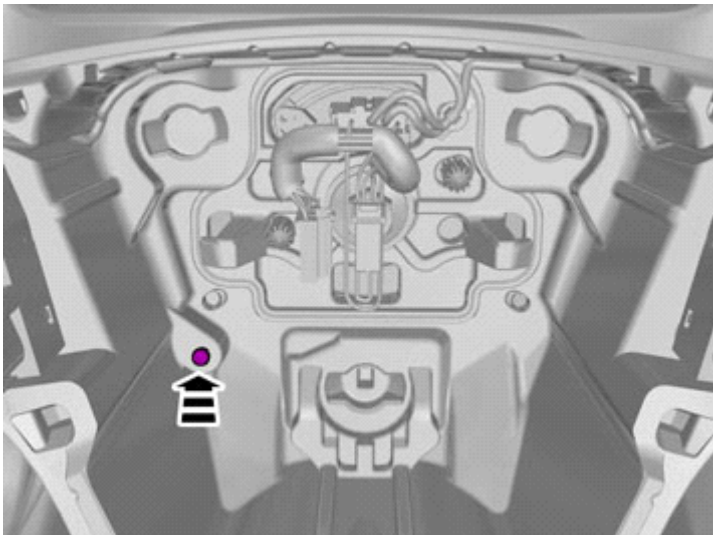

IMG-373394

Install the screw.



# Installation instructions, accessories

Volvo Car Corporation Gothenburg, Sweden

36



IMG-373623

**Tightening torque:** Steering wheel to steering column (center screw) , 48 Nm

37

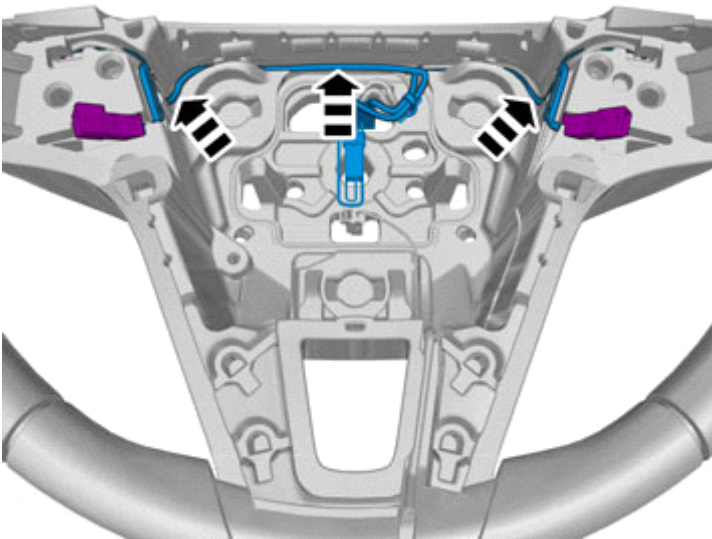

IMG-378459

Install the cable.

38

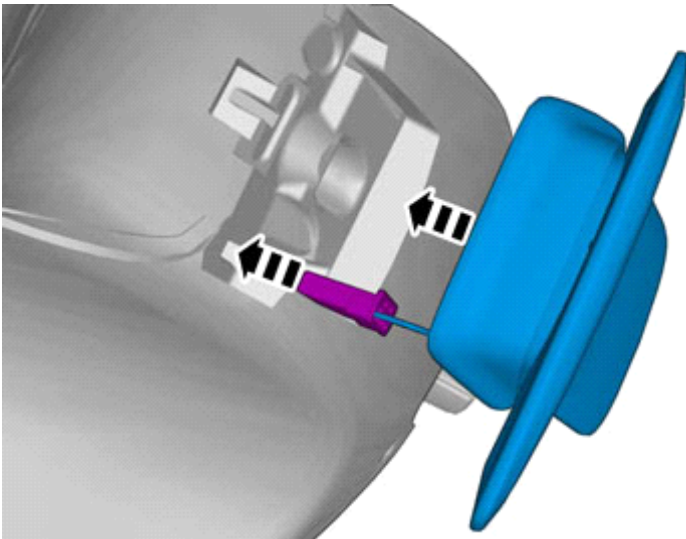

IMG-378449

Repeat on the other side.





# Installation instructions, accessories

Volvo Car Corporation Gothenburg, Sweden

39

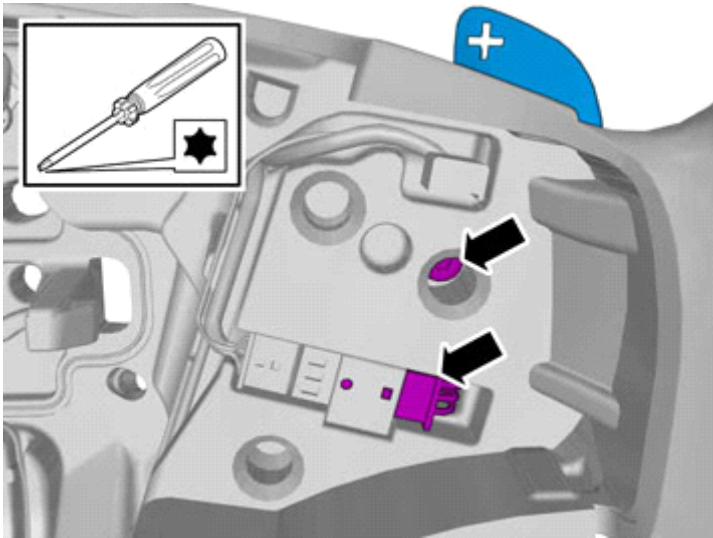

IMG-378450

Repeat on the other side.

## Installation

40

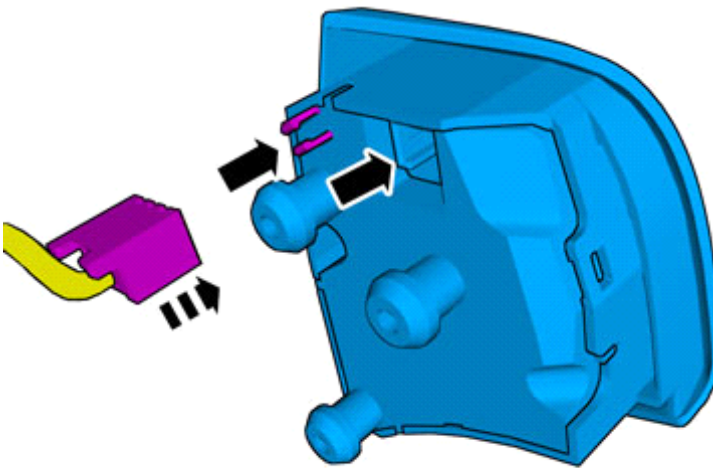

IMG-344510

Repeat on the other side.



# Installation instructions, accessories

Volvo Car Corporation Gothenburg, Sweden

41

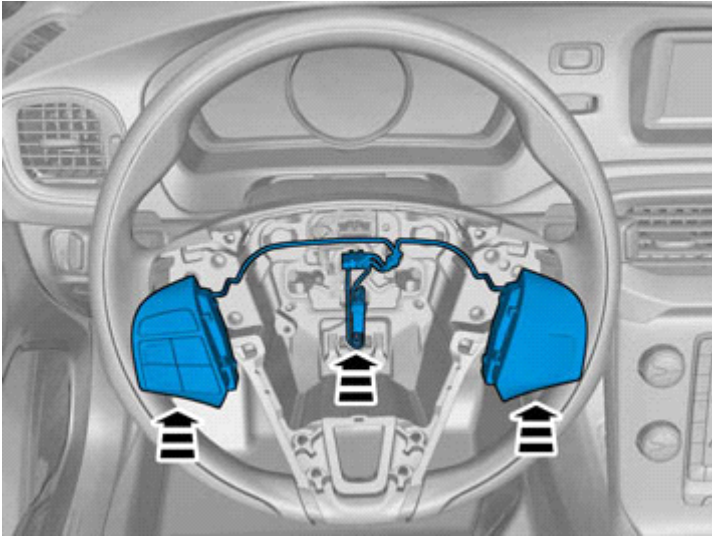

IMG-373385

42

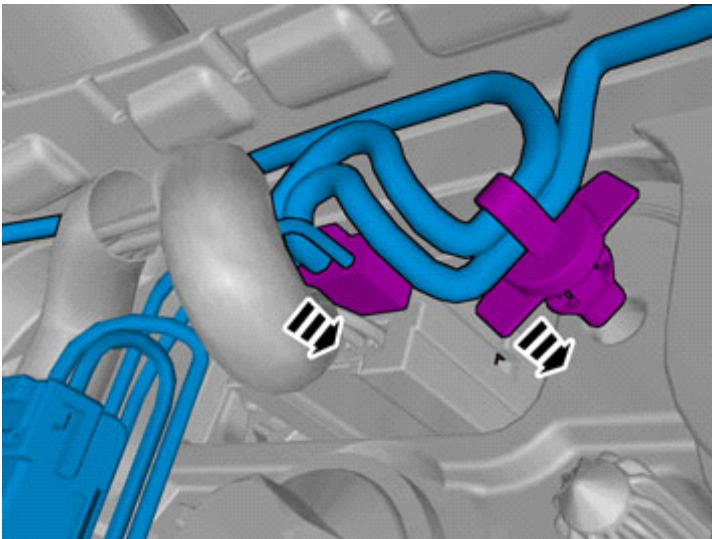

IMG-373389

Connect the connector.

Install the clip(s).

43

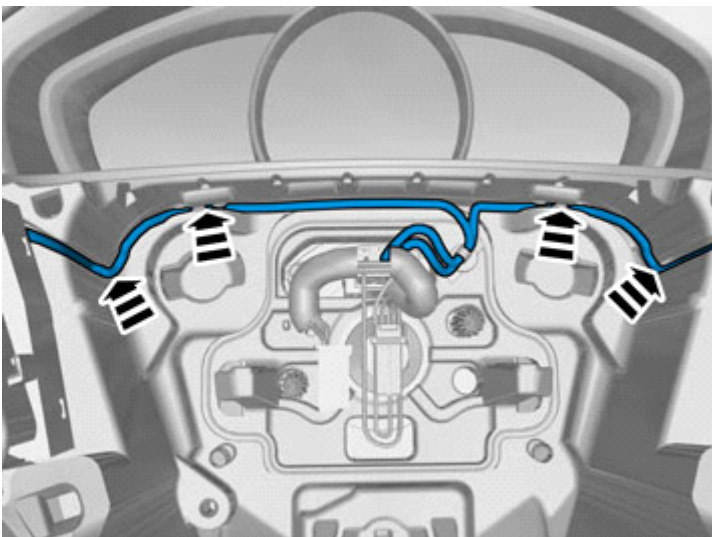

IMG-373390

Install the cable.



# Installation instructions, accessories

Volvo Car Corporation Gothenburg, Sweden

44

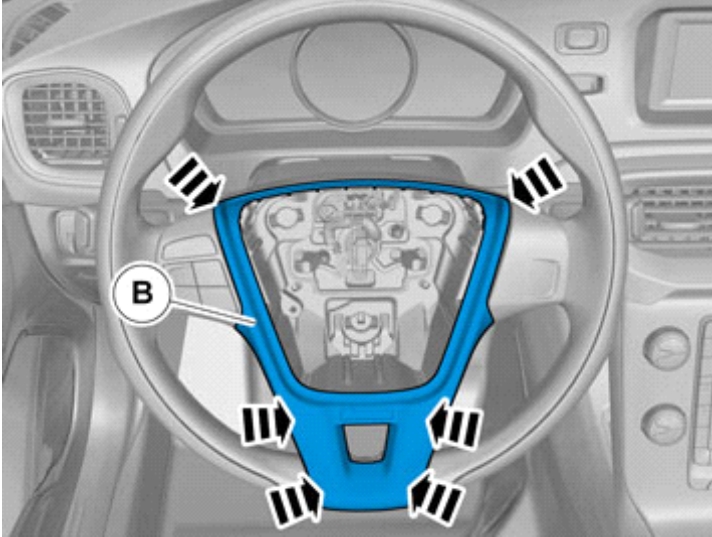

IMG-373388

Install the panel.

45

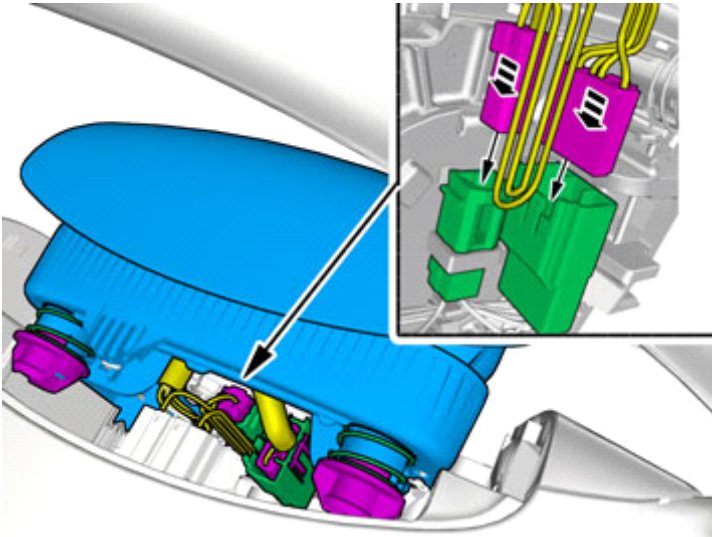

IMG-344748

Connect the connectors.

46

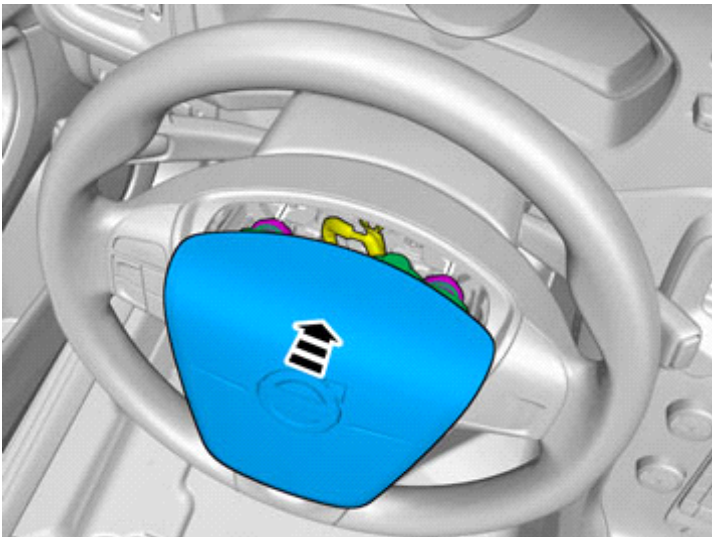

IMG-349387

**Caution!**

Make sure that no part of the wiring harness is trapped.

Reinstall the removed parts in reverse order.



# Installation instructions, accessories

Volvo Car Corporation Gothenburg, Sweden

47

Reinstall the battery's negative cable.

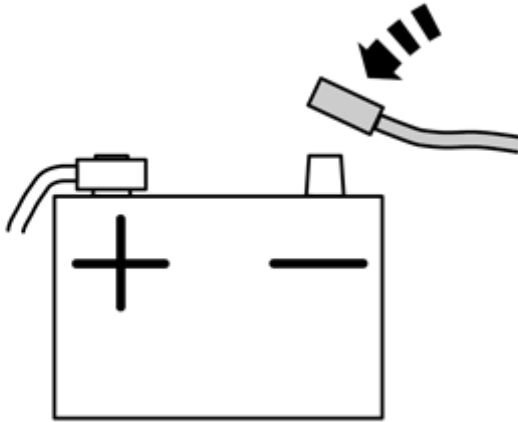

IMG-336901

48

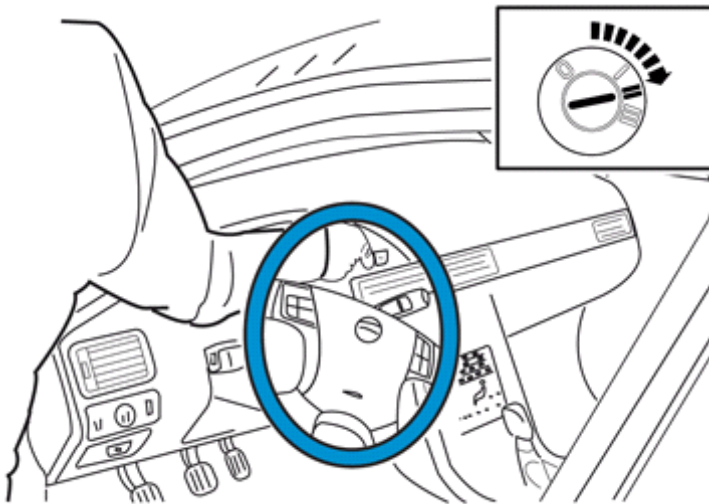

IMG-336904

**Warning!**

When switching the ignition on for the first time after a battery disconnect and connect, make sure to stand outside the vehicle and only reach into the vehicle keeping clear of the air bag deployment areas.